

Contents

How to Select the Butterfly Retrofit Solution pg 83
 Butterfly Valve Retrofit Actuators pg 84

Solutions for Specific Manufacturer and Part Number

Apollo pg 86
 Belimo pg 87
 Bray pg 89
 Centerline pg 91
 Challenger pg 94
 Chemtrol pg 95
 Dezurik pg 96
 Flowseal pg 98
 FNW pg 99
 Gruvlok pg 100
 Hammond pg 102
 Jamesbury pg 103
 Jenkins pg 105
 Johnson Controls pg 106
 Keystone pg 107
 Keystone K-LOK pg 109
 Metraflex pg 111
 Milwaukee pg 112
 Mueller pg 114
 Nibco pg 115
 PDC pg 116
 Quartermaster pg 117
 Victaulic pg 118
 Watts pg 120

Custom Butterfly Valve Retrofit Solutions, Instructions pg 121
 Custom Butterfly Valve Retrofit Solution Form pg 122
 Component Identification pg 123
 UFLK/UFSP Retrofit Solution (2-Way Valves) pg 126
 SY...Series Butterfly Retrofit Solution (2-Way Valves) pg 128
 UFLK/UFSP Retrofit Solution (3-Way Valves) pg 133
 SY...Series Butterfly Retrofit Solution (3-Way Valves) pg 136
 Valve Accessories pg 144
 Custom Ball Valve Retrofit Solutions, Instructions pg 145
 Custom Ball Valve Retrofit Solution Form pg 146
 Actuator/Valve Specification pg 149
 Terms and Conditions pg 153
 Platinum Distributors pg 155

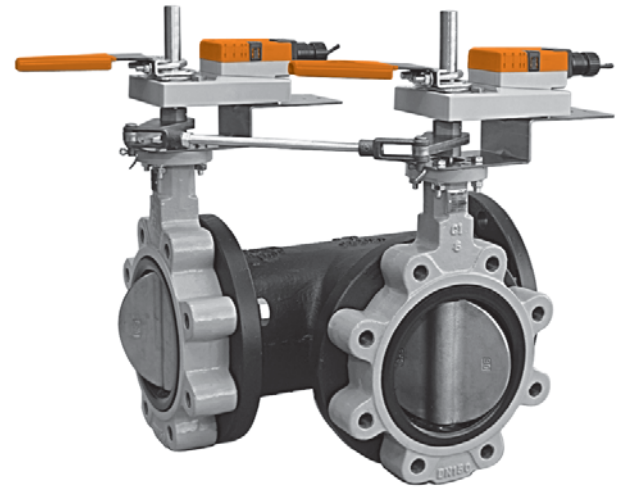

Butterfly Valve:

UFLK Series **Linkage Solution**
 2-way Valves
 3-way Valves

Retrofit Solutions for Virtually any Valve

Manufacturers:

Butterfly: Bray, Centerline, Keystone, Flowseal and more
Control: On/Off, Floating, 2-10VDC Multi-Function Technology®
 Spring Return or Non-Spring Return

SY Series Actuators

Series	Model	Run Time(s) 90°@60Hz	Power Supply	Control			
				Proportional	3 Point	On/Off	Feedback
SY1	SY1-110	12 seconds	120 VAC ±10%, 50/60 Hz		•	•	none, opt 1k
	SY1-24	12 seconds	24 VAC ±10%, 50/60 Hz		•	•	none, opt 1k
	SY1-220	12 seconds	230 VAC ±10%, 50/60 Hz		•	•	none, opt 1k
	SY1-110P	12 seconds	120 VAC ±10%, 50/60 Hz	•			2-10 VDC/4-20 mA
	SY1-24P	12 seconds	24 VAC ±10%, 50/60 Hz	•			2-10 VDC/4-20 mA
	SY1-220P	12 seconds	230 VAC ±10%, 50/60 Hz	•			2-10 VDC/4-20 mA
SY2	SY2-110	15 seconds	120 VAC ±10%, 50/60 Hz		•	•	none, opt 1k
	SY2-24	15 seconds	24 VAC ±10%, 50/60 Hz		•	•	none, opt 1k
	SY2-220	15 seconds	230 VAC ±10%, 50/60 Hz		•	•	none, opt 1k
	SY2-120MFT	15 seconds	120 VAC ±10%, 50/60 Hz	•			2-10 VDC/4-20 mA
	SY2-24MFT	15 seconds	24 VAC ±10%, 50/60 Hz	•			2-10 VDC/4-20 mA
	SY2-230MFT	15 seconds	230 VAC ±10%, 50/60 Hz	•			2-10 VDC/4-20 mA
SY3	SY3-110	22 seconds	120 VAC ±10%, 50/60 Hz		•	•	none, opt 1k
	SY3-24	22 seconds	24 VAC ±10%, 50/60 Hz		•	•	none, opt 1k
	SY3-220	22 seconds	230 VAC ±10%, 50/60 Hz		•	•	none, opt 1k
	SY3-24MFT	22 seconds	120 VAC ±10%, 50/60 Hz	•			2-10 VDC/4-20 mA
	SY3-120MFT	22 seconds	120 VAC ±10%, 50/60 Hz	•			2-10 VDC/4-20 mA
	SY3-230MFT	22 seconds	230 VAC ±10%, 50/60 Hz	•			2-10 VDC/4-20 mA
SY4	SY4-110	16 seconds	120 VAC ±10%, 50/60 Hz		•	•	none, opt 1k
	SY4-24	16 seconds	24 VAC ±10%, 50/60 Hz		•	•	none, opt 1k
	SY4-220	16 seconds	230 VAC ±10%, 50/60 Hz		•	•	none, opt 1k
	SY4-24MFT	16 seconds	120 VAC ±10%, 50/60 Hz	•			2-10 VDC/4-20 mA
	SY4-120MFT	16 seconds	120 VAC ±10%, 50/60 Hz	•			2-10 VDC/4-20 mA
	SY4-230MFT	16 seconds	230 VAC ±10%, 50/60 Hz	•			2-10 VDC/4-20 mA
SY5	SY5-110	22 seconds	120 VAC ±10%, 50/60 Hz		•	•	none, opt 1k
	SY5-24	22 seconds	24 VAC ±10%, 50/60 Hz		•	•	none, opt 1k
	SY5-220	22 seconds	230 VAC ±10%, 50/60 Hz		•	•	none, opt 1k
	SY5-24MFT	22 seconds	120 VAC ±10%, 50/60 Hz	•			2-10 VDC/4-20 mA
	SY5-120MFT	22 seconds	120 VAC ±10%, 50/60 Hz	•			2-10 VDC/4-20 mA
	SY5-230MFT	22 seconds	230 VAC ±10%, 50/60 Hz	•			2-10 VDC/4-20 mA
SY6	SY6-110	28 seconds	120 VAC ±10%, 50/60 Hz		•	•	none, opt 1k
	SY6-220	28 seconds	230 VAC ±10%, 50/60 Hz		•	•	none, opt 1k
	SY6-120MFT	28 seconds	120 VAC ±10%, 50/60 Hz	•			2-10 VDC/4-20 mA
	SY6-230MFT	28 seconds	230 VAC ±10%, 50/60 Hz	•			2-10 VDC/4-20 mA
SY7	SY7-110	46 seconds	120 VAC ±10%, 50/60 Hz		•	•	none, opt 1k
	SY7-220	46 seconds	230 VAC ±10%, 50/60 Hz		•	•	none, opt 1k
	SY7-120MFT	46 seconds	120 VAC ±10%, 50/60 Hz	•			2-10 VDC/4-20 mA
	SY7-230MFT	46 seconds	230 VAC ±10%, 50/60 Hz	•			2-10 VDC/4-20 mA
SY8	SY8-110	46 seconds	120 VAC ±10%, 50/60 Hz		•	•	none, opt 1k
	SY8-220	46 seconds	230 VAC ±10%, 50/60 Hz		•	•	none, opt 1k
	SY8-120MFT	46 seconds	120 VAC ±10%, 50/60 Hz	•			2-10 VDC/4-20 mA
	SY8-230MFT	46 seconds	230 VAC ±10%, 50/60 Hz	•			2-10 VDC/4-20 mA

Proportional actuators will accept 0-10 VDC, 2-10 VDC, or 4-20 mA control signals as standard.
 All SY actuators are non-spring return, but can be used with NSV-SY back up systems for fail safe applications.
 These products carry a two year warranty when sold as part of an assembly or with a UFLK retrofit kit.

L30043 - 07/09 - SUBJECT TO CHANGE. © BELIMO AIRCONTROLS (USA), INC.

SY Series Actuators

Series	Model	Run Time(s) 90°@60Hz	Power Supply	Control			
				Proportional	3 Point	On/Off	Feedback
SY9	SY9-110	58 seconds	120 VAC ±10%, 50/60 Hz		•	•	none, opt 1k
	SY9-220	58 seconds	230 VAC ±10%, 50/60 Hz		•	•	none, opt 1k
	SY9-120MFT	58 seconds	120 VAC ±10%, 50/60 Hz	•			2-10 VDC/4-20 mA
	SY9-230MFT	58 seconds	230 VAC ±10%, 50/60 Hz	•			2-10 VDC/4-20 mA
SY10	SY10-110	58 seconds	120 VAC ±10%, 50/60 Hz		•	•	none, opt 1k
	SY10-220	58 seconds	230 VAC ±10%, 50/60 Hz		•	•	none, opt 1k
	SY10-120MFT	58 seconds	120 VAC ±10%, 50/60 Hz	•			2-10 VDC/4-20 mA
	SY10-230MFT	58 seconds	230 VAC ±10%, 50/60 Hz	•			2-10 VDC/4-20 mA
SY11	SY11-110	58 seconds	120 VAC ±10%, 50/60 Hz		•	•	none, opt 1k
	SY11-220	58 seconds	230 VAC ±10%, 50/60 Hz		•	•	none, opt 1k
	SY11-120MFT	58 seconds	120 VAC ±10%, 50/60 Hz	•			2-10 VDC/4-20 mA
	SY11-230MFT	58 seconds	230 VAC ±10%, 50/60 Hz	•			2-10 VDC/4-20 mA
SY12	SY12-110	58 seconds	120 VAC ±10%, 50/60 Hz		•	•	none, opt 1k
	SY12-220	58 seconds	230 VAC ±10%, 50/60 Hz		•	•	none, opt 1k
	SY12-120MFT	58 seconds	120 VAC ±10%, 50/60 Hz	•			2-10 VDC/4-20 mA
	SY12-230MFT	58 seconds	230 VAC ±10%, 50/60 Hz	•			2-10 VDC/4-20 mA

Proportional actuators will accept 0-10 VDC, 2-10 VDC, or 4-20 mA control signals as standard.

All SY actuators are non-spring return, but can be used with NSV-SY back up systems for fail safe applications.

These products carry a two year warranty when sold as part of an assembly or with a UFLK retrofit kit.

SY Multi-Function Technology

Description	P-CODE	Control Input	Built-in Feedback	Loss of Signal	Running Time
MFT	ACE	2...10V	2...10V	stop	actuator(s) constant
MFT	ACF	0.5...10V	0.5...10V	stop	actuator(s) constant
MFT	ACG	4...20mA	4...20mA	stop	actuator(s) constant
MFT	ACH	4...20mA	2...10V	stop	actuator(s) constant
MFT	ACJ	2...10V	2...10V	open	actuator(s) constant
MFT	ACK	0.5...10V	0.5...10V	open	actuator(s) constant
MFT	ACL	4...20mA	4...20mA	open	actuator(s) constant
MFT	ACM	4...20mA	2...10V	open	actuator(s) constant
MFT	ACN	2...10V	2...10V	close	actuator(s) constant
MFT	ACP	0.5...10V	0.5...10V	close	actuator(s) constant
MFT	ACR	4...20mA	4...20mA	close	actuator(s) constant
MFT	ACS	4...20mA	2...10V	close	actuator(s) constant

Rotary Actuators

Series	Model	Spring Return	Control Input	Feedback Position	Power Supply
AF Series*	AF24 US	•	24 VAC/DC		24 VAC/DC
	AF24-MFT US	•	Variable with MFT (VDC, PWM, Floating Pt., On/Off)	variable VDC	24 VAC/DC
AM Series*	AMB24-3X1		24 VAC/DC		24 VAC/DC
	AMB24-MFTX1		Variable with MFT (VDC, PWM, Floating Pt., On/Off)	variable VDC	24 VAC/DC
GM Series*	GMB24-3X1		24 VAC/DC		24 VAC/DC
	GMB24-MFTX1		Variable with MFT (VDC, PWM, Floating Pt., On/Off)	variable VDC	24 VAC/DC

*Please consult the Product Guide and Price List for a complete selection of Spring Return and Non-Spring Return Actuators of the listed series.

Standard run times should be considered in the selection.

Multi-Function Technology

ROTARY ACTUATOR CODES	Programming Codes		Control Input	Running Time	Built-in Feedback
		P-10001	A01	2-10 VDC	150 seconds
	P-10002	A02	0-10 VDC	150 seconds	0-10 VDC
	P-10028	A28	0-10 VDC	150 seconds	0-10 VDC
	P-10063	A63	0.5-4.5 VDC	150 seconds	0.5-4.5 VDC
	P-10064	A64	5.5-10 VDC	150 seconds	5.5-10 VDC
	P-20002	W02	0.02-5.00 seconds PWM	150 seconds	2-10 VDC
	P-20003	W03	0.10-25.5 seconds PWM	150 seconds	2-10 VDC
	P-30001	F01	Floating Pt.	150 seconds	2-10 VDC
	P-40002	J02	On/Off	150 seconds	2-10 VDC

2-way Valves

		Spring Return				Non-Spring Return			
Actuator		AF	2*AF	2*AF	2*AF	AM	GM	GM	2*GM
Linkage		UFLK3930	UFLK3936	UFLK3938	UFLK3940	UFLK3900	UFLK3904	UFLK3905	UFLK3910
Size	Close-off psi								
2"	50	UFLK3930				UFLK3900			
2½"	50	UFLK3930				UFLK3900			
3"	50		UFLK3936			UFLK3900			
4"	50			UFLK3938			UFLK3904		
5"	50				UFLK3940			UFLK3905	
6"	50								UFLK3910

		SY						
Actuator		SY1	SY2	SY2	SY2	SY3	SY3	SY4
Linkage		UFLK3912	UFLK3918	UFLK3920	UFLK3922	UFLK3924	UFLK3926	UFLK3928
Size	Close-off psi							
2"	50	UFLK3912	UFLK3918					
2½"	50	UFLK3912	UFLK3918					
3"	50	UFLK3912	UFLK3918					
4"	50			UFLK3920				
5"	50				UFLK3922			
6"	50				UFLK3922			
8"	50					UFLK3924		
10"	50						UFLK3926	
12"	50							UFLK3928

3-way Valves

		Spring Return			Non-Spring Return		
Actuator		AF	2*AF	GM	2*GM	2*GM	
Linkage		UFLK6950	UFLK6952	UFLK6900	UFLK6904	UFLK6906	
Size	Close-off psi						
2"	50	UFLK6950		UFLK6900			
2½"	50		UFLK6952	UFLK6900			
3"	50		UFLK6952	UFLK6900			
4"	50				UFLK6904		
5"	50					UFLK6906	
6"	50					UFLK6906	

		SY						
Actuator		SY1	SY2	SY2	SY2	SY3	SY4	SY4
Linkage		UFLK6908	UFLK6910	UFLK6912	UFLK6914	UFLK6919	UFLK6920	UFLK6922
Size	Close-off psi							
2"	50	UFLK6908	UFLK6910					
2½"	50	UFLK6908	UFLK6910					
3"	50		UFLK6910					
4"	50			UFLK6912				
5"	50				UFLK6914			
6"	50				UFLK6914			
8"	50					UFLK6919		
10"	50						UFLK6920	
12"	50							UFLK6922

L30043 - 07/09 - SUBJECT TO CHANGE. © BELIMO AIRCONTROLS (USA), INC.

2-way Valves

		Spring Return		Non-Spring Return			SY			
Actuator		AF	2*AF	AM	GM	2*GM	SY2	SY2	SY2	SY3
Linkage		UFLK3930	UFLK3936	UFLK3900	UFLK3900	UFLK3908	UFLK3918	UFLK3920	UFLK3922	UFLK3922
Size	Close-off psi									
2"	200	UFLK3930		UFLK3900			UFLK3918			
2½"	200		UFLK3936	UFLK3900			UFLK3918			
3"	200		UFLK3936		UFLK3900		UFLK3918			
4"	200					UFLK3908		UFLK3920		
5"	200								UFLK3922	
6"	200									UFLK3922

		SY						
Actuator		SY4	SY4	SY4	SY5	SY6	SY8	SY11
Linkage		UFLK3968	UFLK3970	UFLK3928	UFLK3928	UFLK3976	UFLK3978	UFLK3982
Size	Close-off psi							
8"	200	UFLK3968						
10"	200		UFLK3970					
12"	200			UFLK3928				
14"	150				UFLK3928			
16"	150					UFLK3976		
18"	150						UFLK3978	
20"	150							
24"	150							UFLK3982

3-way Valves

		Spring Return		Non-Spring Return		SY			
Actuator		AF	2*AF	AM	2*GM	SY2	SY2	SY3	SY4
Linkage		UFLK6950	UFLK6952	UFLK6900	UFLK6902	UFLK6910	UFLK6912	UFLK6914	UFLK6920
Size	Close-off psi								
2"	200	UFLK6950		UFLK6900		UFLK6910			
2½"	200		UFLK6952		UFLK6902	UFLK6910			
3"	200				UFLK6902	UFLK6910			
4"	200						UFLK6912		
5"	200							UFLK6914	
6"	200							UFLK6914	
8"	200								UFLK6920

		SY						
Actuator		SY4	SY5	SY6	SY7	SY8	SY9	SY12
Linkage		UFLK6920	UFLK6922	UFLK7018	UFLK7020	UFLK7022	UFLK7024	UFLK7026
Size	Close-off psi							
10"	200	UFLK6920						
12"	200		UFLK6922					
14"	150			UFLK7018				
16"	150				UFLK7020			
18"	150					UFLK7022		
20"	150						UFLK7024	
24"	150							UFLK7026

L-30043 - 07/09 - SUBJECT TO CHANGE. © BELIMO AIRCONTROLS (USA), INC.

3-way Single Actuator

Generic – Must complete BFV Retrofit Form

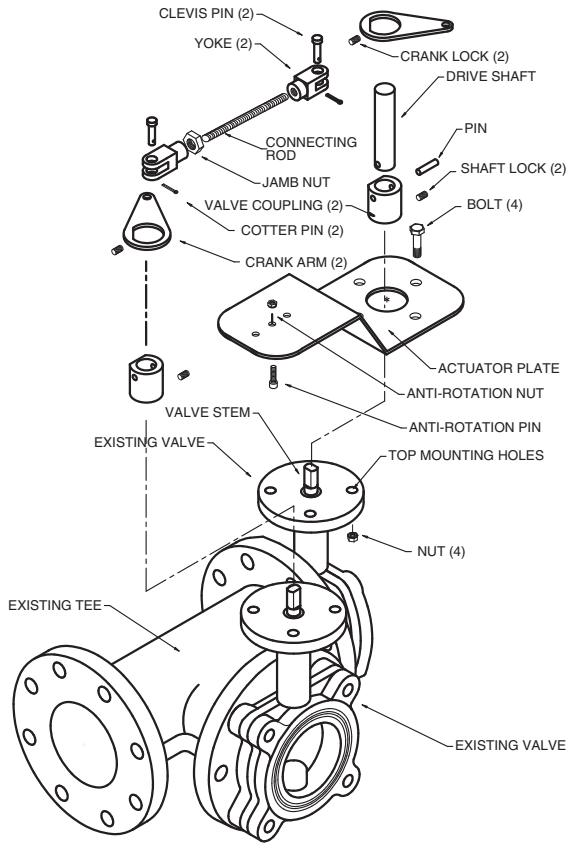

UFSP0002

3-way Dual Actuator

Generic – Must complete BFV Retrofit Form

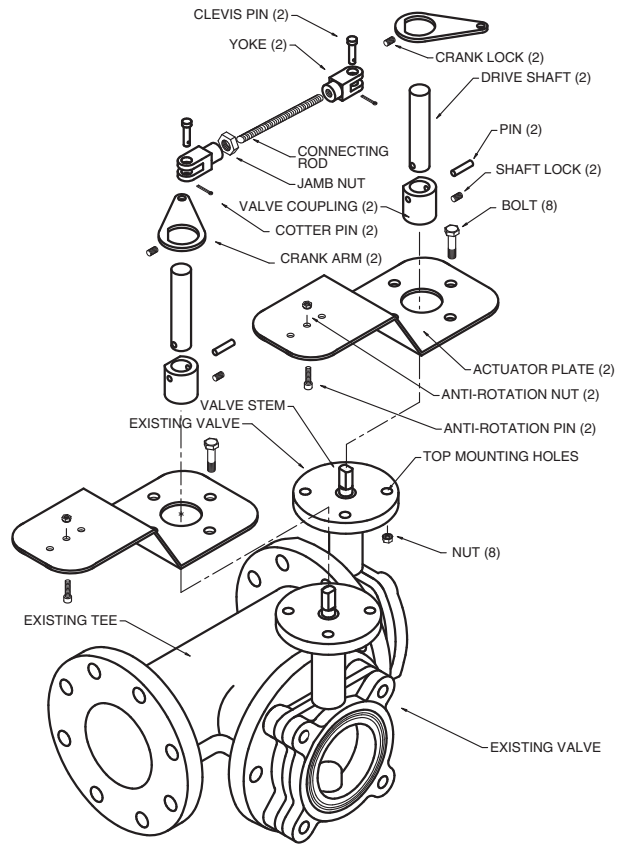

UFSP0010

NOTE: 3-way bracket configuration shown is only one of many possible arrangements.

L-30043 - 07/09 - SUBJECT TO CHANGE. © BELIMO AIRCONTROLS (USA), INC.

UFLK/UFSP Series Butterfly Valve Retrofit Solution

Retrofitting 3-way Valves with Belimo Direct Coupled Actuator(s)



Assembly Sequence for Existing Valves

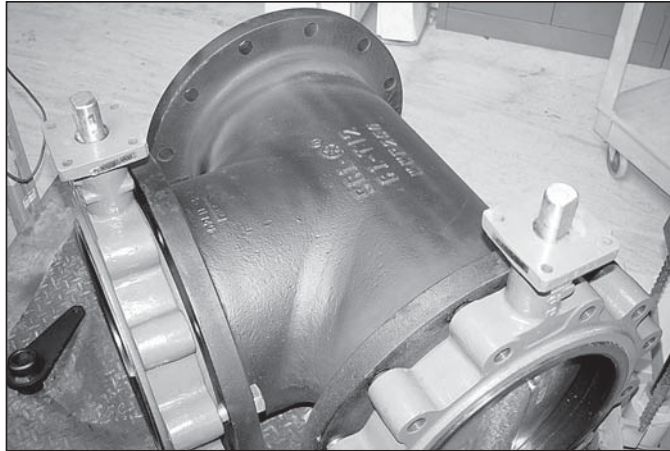

The valves should be stripped down to their basic form, as shown. Remove all other linkage components before starting the assembly sequence below. The linkage components have been designed to attach to the valve in this state, rather than to any existing hardware.

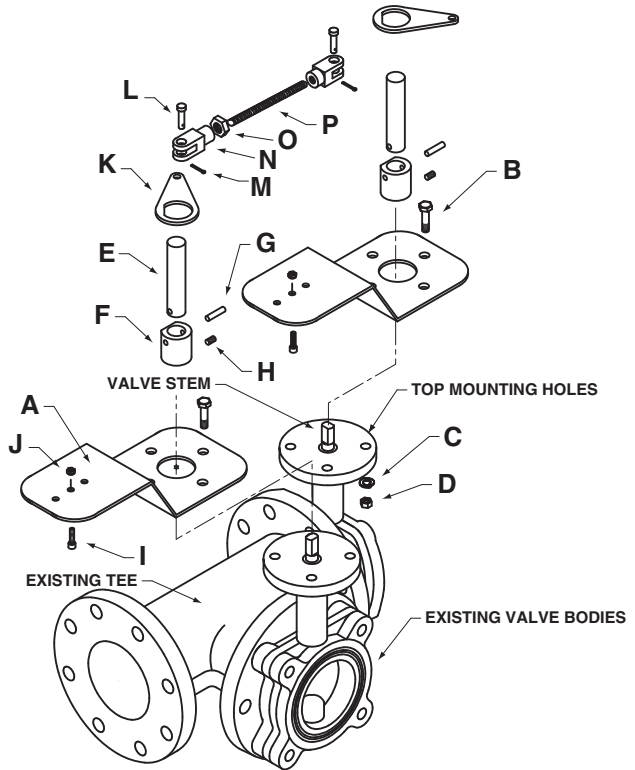

Please refer to the above exploded view above when following the assembly procedure, to better identify which parts are being addressed in each step. Additionally, you need to determine the configuration of the valve you are trying to retrofit, using one of the three diagrams below:

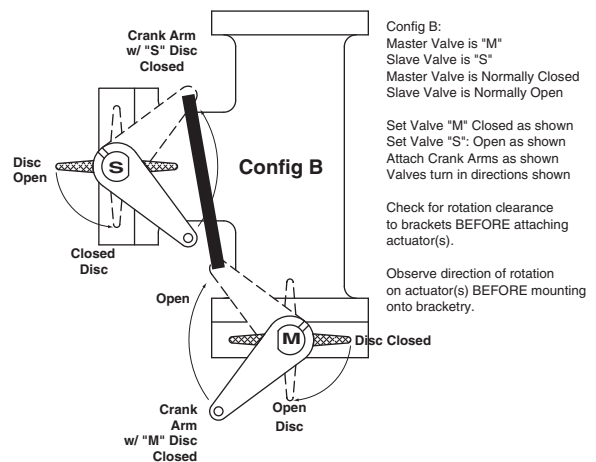
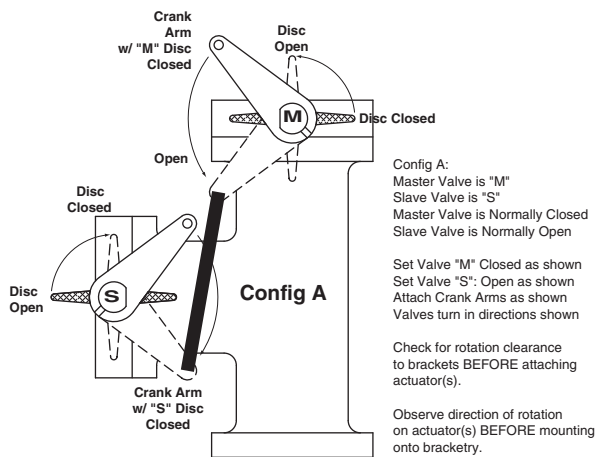

Depending on the orientation of the tee assembly, if the valves are mounted on the TOP and BRANCH positions (tee mounted vertically), or on the LEFT and BRANCH positions (tee mounted horizontally) you will refer to configuration directions **A**.

If the valves are mounted on the BOTTOM and BRANCH positions (tee mounted vertically), or on the RIGHT and BRANCH positions (tee mounted horizontally) you will refer to configuration directions **B**.

Assembly Sequence for Existing Valves

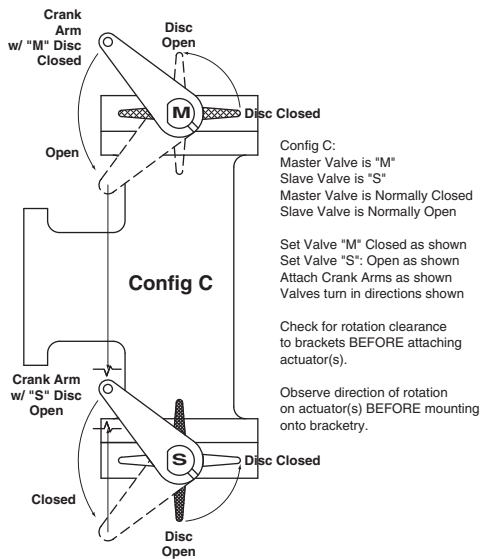

If the valves are mounted on the TOP and BOTTOM positions (tee mounted vertically), or on the LEFT and RIGHT positions (tee mounted horizontally) you will refer to configuration directions **C**.

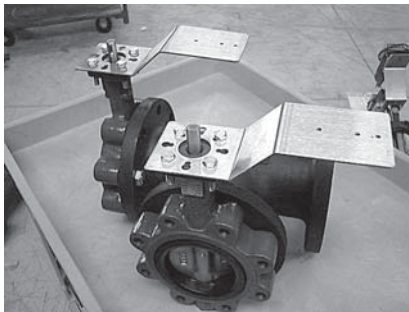

Step 1) Assemble the actuator mounting bracket(s) **(A)** to the top of the valve actuator mounting pad(s) using the supplied bolts **(B)**, lock washers **(C)** and nuts **(D)**. The bracket(s) need to be oriented so that they are parallel to the

RUN of the tee, unless you have configuration types C, in which case the bracket(s) must be mounted parallel to the BRANCH of the tee.

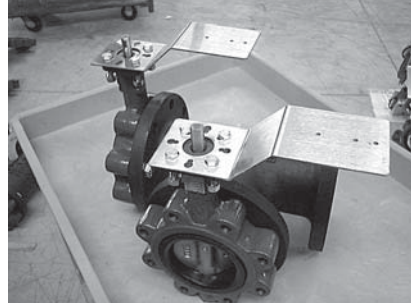

Step 2) Refer to the three configuration drawing types on pages 133 and 134 and position the valve discs as instructed. For example, if you have a Configuration Type A tee assembly, you will OPEN the master valve **(A)**, and CLOSE the slave

valve **(B)**. During the assembly procedure, CLOSED and OPEN means 0 degrees and 90 degrees respectively. Failure to position the discs into their quadrants will result in improper operation and performance of the retrofit kit. Most manufacturers mark the TOP of the valve stem with a slot which indicates the disc angle.

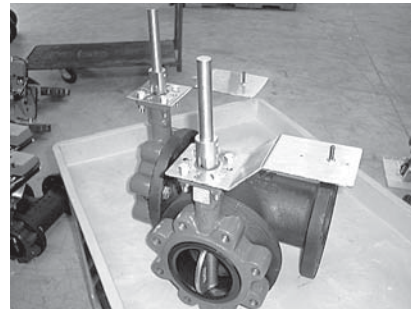

Step 3) Slide the drive pin assembly, consisting of the drive shaft(s) **(E)**, the valve shaft couplings **(F)**, the mating pins **(G)**, and the setscrews **(H)**, over the valve shafts. It may be necessary to back out the set screws **(H)** a few turns to make

sure there is clearance in the coupling pockets (bottom of **(F)**) for the valve shafts. Drive shafts **(E)** should be concentric and parallel with the valve shafts so there is no binding. Any angular alignment MUST be corrected before moving on to the next step.

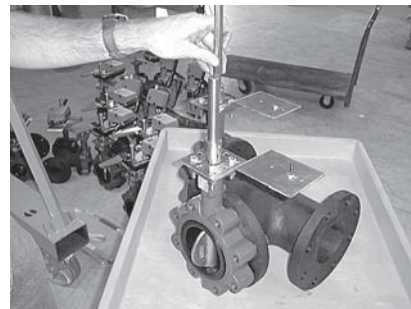

Step 4) Mark the top of each drive shaft **(E)** to indicate the disc position. Typically, this is done using a chisel to punch a line PARALLEL to the valve disc to make it easier to identify the disc position during the assembly process.

UFLK/UFSP Series Butterfly Valve Retrofit Solution

Retrofitting 3-way Valves with Belimo Direct Coupled Actuator(s)



Assembly Sequence for Existing Valves

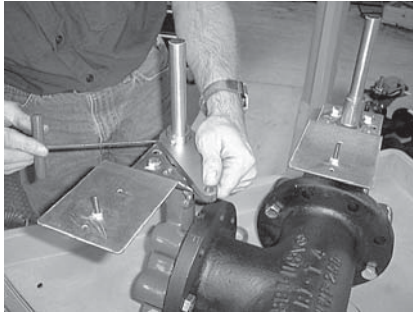

Step 5) Refer to the three configuration drawing types and position the crank arms (K) as instructed. Slide the crank arms over valve couplings (F), and position just below the top edge of the couplings. Tighten setscrews (H) to affix the crank arms (K) to the couplings (F).

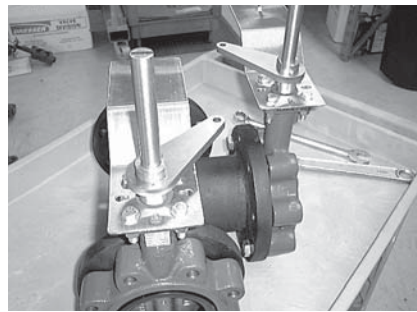

Step 6) Once the crank arms (K) are attached to the assembly, again refer to the drawings to make sure the entire assembly matches the corresponding configuration type.

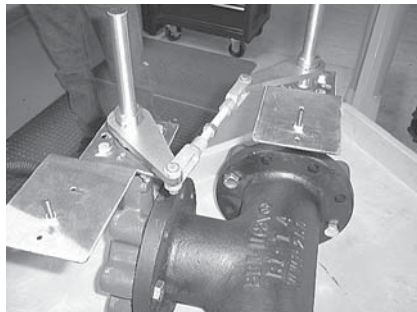

Step 7) The connecting rod (P) is supplied long enough to meet all configuration types, and will have to be modified in the field to properly fit your assembly. Connecting rod (P) is furnished with jamb nut (O), yoke (N), clevis pin

(L) and cotter key (M) attached to one end, and the second yoke assembly attached to the opposite end. Remove the yoke assembly from the end without the jamb nut (O). Remove the cotter pins (M) and clevis pins (L) from both yokes (N). With the valve discs and crank arms (K) properly positioned, attach the end of the connecting rod (P) with the still attached yoke (N), to one of the crank arms (K), and reinstall clevis pin (L) to retain its position. Attach the free yoke (N) to the second crank arm (K) and again use the clevis pin (L) to retain its position. Point the connecting rod (P) towards the second yoke and align the yoke (N) with the connecting rod (P). You will now have an idea of where to CUT the connecting rod (P) for a proper fit. The correct length is attained when the ENDS of the connection rod (P) are even with the INSIDE ends of the threads on the yokes (N). Be sure to tighten the jamb nut (O) after the proper length has been attained. Reinstall the cotter pins (M) in both clevis pins (L) and bend to retain.

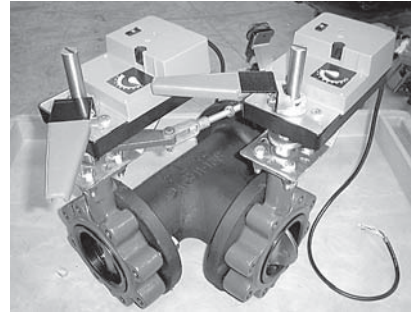

Step 8) Assemble the actuator(s) to the linkage by sliding the actuator shaft clamp over the kit drive shaft(s) (E). The actuator anti-rotation pin(s) (I) should already be positioned in the correct hole for the actuator, but they can be moved to

accommodate AM, GM or AF series actuators. Make sure the anti-rotation pin nut(s) (J) is tight. Make sure the bottom of the actuator(s) is PARALLEL to the mounting plate (A) when tightening the actuator clamp nuts. If this is not checked, it is possible that binding could cause erratic movement of the valve disc due to reduced torque transmission to the valve shaft(s). For AF series actuators, release the pre-load on the spring before tightening the clamp nuts, as the valve discs have already been positioned at their full travel stops in step 2 above.

Step 9) Keep in mind that for dual actuator retrofits, the actuators turn in OPPOSITE directions. AF series actuators have to be mounted with opposite sides UP, and GM series actuators will need to have their rev/dir acting switches changed so one is opposite the other.

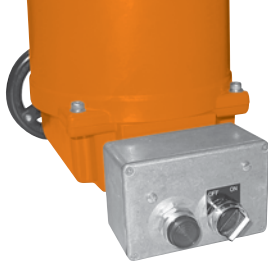

**SY-HOA...
Local Electric Disconnect**



NSV-SY...Battery Backup System



SY...Handwheel

SY-HOA-110	Local Electric Disconnect SY2-SY12 110V 2 Position
SY-HOA-110P	Local Electric Disconnect SY2-SY12 110V Proportional
SY-HOA-24	Local Electric Disconnect SY2-SY12 24V 2 Position
SY-HOA-24P	Local Electric Disconnect SY2-SY12 24V Proportional

SY-1000-FB01	1000 Ω Feedback Potentiometer SY2-12 2 Position
SY-1000-FB02	1000 Ω Feedback Potentiometer SY2-12 Proportional

NSV-SY-01	Battery Backup System for SY1-SY6 2 Position - 110 VAC
NSV-SY-02	Battery Backup System for SY1-SY6 Proportional - 110 VAC
NSV-SY-03	Battery Backup System for SY7 2 Position - 110 VAC
NSV-SY-04	Battery Backup System for SY7 Proportional - 110 VAC
NSV-SY-05	Battery Backup System for SY8-SY12 2 Position - 110 VAC
NSV-SY-06	Battery Backup System for SY8-SY12 Proportional - 110 VAC
NSV-SY-11	Battery Backup System for SY1-SY5 2 Position - 24 VAC
NSV-SY-12	Battery Backup System for SY1-SY5 Proportional - 24 VAC
NSV-SY-21	Battery Backup System for SY1-SY6 2 Position - 220 VAC
NSV-SY-22	Battery Backup System for SY1-SY6 Proportional - 220 VAC
NSV-SY-23	Battery Backup System for SY7-SY9 2 Position - 220 VAC
NSV-SY-24	Battery Backup System for SY7-SY9 Proportional - 220 VAC
NSV-SY-25	Battery Backup System for SY10-SY12 2 Position - 220 VAC
NSV-SY-26	Battery Backup System for SY10-SY12 Proportional - 220 VAC

ZG-SY23	SY2-3 Handwheel (replacement only)
ZG-SY46	SY4-6 Handwheel (replacement only)
ZG-SY78	SY7-8 Handwheel (replacement only)
ZG-SY912	SY9-12 Handwheel (replacement only)